

**Digital voice recorder**  
**EDIC-mini LCD**

***Operation manual***

***Version 05.08.29***

© TS-Market

## Contents

<b>Introduction</b> .....	<b>3</b>
<b>Purpose</b> .....	<b>3</b>
<b>Delivery set</b> .....	<b>4</b>
<b>Basic technical and functional features</b> .....	<b>4</b>
<b>DVR overview</b> .....	<b>7</b>
<b>Display symbols</b> .....	<b>8</b>
<b>DVR operating</b> .....	<b>9</b>
Prestating procedures .....	9
Battery installation and replacement .....	9
Earphone and remote control connection .....	11
<b>Operating modes</b> .....	<b>12</b>
Record mode (REC) .....	12
Playback mode (PLAY) .....	15
Erasing mode (CLEAR) .....	16
Tuning mode (REC PR) .....	17
Setup mode (SETUP) .....	18
Profile setting mode .....	20
Recording startup by timer .....	22
Standby mode (Stop mode) .....	23
Energy-saving mode .....	23
Admission levels .....	23
Antialiasing median program filter .....	24
<b>Connection to computer</b> .....	<b>24</b>
System requirements .....	24
Connection .....	24
Firmware updating .....	25
<b>DVR accessories</b> .....	<b>26</b>
External microphone with a compressor, combined with the remote control .....	26
Phone talk record adapter .....	27
Record adapter for cellular phone with a stereo connector .....	27
<b>Troubleshooting: possible causes and corrective measures</b> .....	<b>28</b>
<b>Technical support</b> .....	<b>30</b>
<b>Control chart</b> .....	<b>32</b>
<b>Guarantee card</b> .....	<b>40</b>

## **Introduction**

Thank you for purchasing the Edic-Mini LCD digital voice recorder (DVR). Prior to operation, read the operation manual thoroughly.

## **Purpose**

Voice recorders of the Edic-mini LCD series are professional devices intended for making high quality recording of voice messages into built-in flash-memory. You can playback recorded messages using headphone and save them in your computer as standard audio files. Voice recorders feature extremely small dimensions and weight, long record time (varies with the model up to 600 hours), standby operation (up to 1000 hours), and highly sensitive built-in microphone with a wide dynamic range. Due to the absence of moving parts, the DVR functions even under the conditions of strong vibration, dustiness, and low temperatures.

The supplied USB adapter provides high-speed data exchange between the DVR and the computer (1.5 Mb). The software supplied on the CD makes it possible to save the recorded messages as standard audio files, set the DVR parameters, and control admission to the DVR functions. You may use your DVR for message recording, as well as a flash-disc at the same time, to store and transfer data of any format.

For the user's convenience, while operating the DVR, there is a push-button manipulator (joystick) and a liquid-crystal display to indicate all the information needed, including a built-in timer and a real time clock. The DVR has a Voice Activating System (VAS) which effectively compresses pauses in messages therefore increasing the actual recording time. The pause length can be restored at further file processing with the software supplied.

## Delivery set

- Edic-Mini LCD digital voice recorder
- Headphone
- USB adapter
- CD with software
- 2 batteries
- Operation manual
- Guarantee card

## Basic technical and functional features

1. Available recording time in ExtraLongPlay mode (modified 2-bit ADPCM, sample rate 8 kHz, 16 Kbit/s).

<b>Index</b>	<b>Record time</b>	<b>Built-in flash memory size</b>
560	560 min.(9.3 hours)	64 MB
1120	1120 min. (18.6 hours)	128 MB
2240	2240 min.(37.3 hours)	256 MB
4480	4480 min. (74.6 hours)	512 MB
8960	8960 min. (149.3 hours)	1 GB
17920	17920 min. (298.6 hours)	2 GB

The DVR features a SuperExtraLongPlay mode (modified 2-bit ADPCM, sample rate 4 kHz, 8 Kbit/s), which increases the recording time twice as much as regards the data in the table.

- Supply voltage: 2.7-3.2 V;
- Operating temperature: -20- +50°C (68-122F);
- Maximum bandwidth:
  - at playback on PC: 100-6000 Hz;
  - at playback through the earphone: 100-3800 Hz;
- Sample rate: 16000, 8000, 4000 Hz;
- Codec capacity: 16 bits;
- Signal/noise ratio: 72 dB;
- Quality, formats and density of data record:
  - Without compression (linear), sampling rate is 16 kHz, 256 Kbit/s,  $k=16$
  - Without compression (linear), sampling rate is 8 kHz, 128 Kbit/s,  $k=8$
  - Without compression (linear), sampling rate is 4 kHz, 64 Kbit/s,  $k=4$
  - Logarithmic compression, sampling rate is 16 kHz, 128 Kbit/s,  $k=8$
  - Logarithmic compression, sampling rate is 8 kHz, 64 Kbit/s,  $k=4$
  - Logarithmic compression, sampling rate is 4 kHz, 32 Kbit/s,  $k=2$
  - Modified 4-bit ADPCM, sampling rate is 8 kHz, 32 Kbit/s,  $k=2$
  - Modified 2-bit ADPCM, sampling rate is 8 kHz, 16 Kbit/s,  $k=1$
  - Modified 4-bit ADPCM, sampling rate is 4 kHz, 16 Kbit/s,  $k=1$
  - Modified 2-bit ADPCM, sampling rate is 4 kHz, 8 Kbit/s,  $k=0.5$

where  $k$  is the coefficient, showing how many times the maximum recording time decreases when record quality increases.
- Automated Voice Activation System (VAS);
- Antialiasing median program filter;
- Recording in the linear and circular modes (in the circular mode, the buffer size is set in per cent of total memory size);
- Built-in microphone sensitivity: 7-9 m.;
- 8 user sets of record parameters (profiles);
- Random record delete;
- Real time clock;
- Battery charge indicator;
- USB interface with a PC, data exchange speed: 1.5 Mb;

- Reliable data storage in flash-memory: over 10 years;
- Consumption in Standby mode with the indicator on: 0.14 mA;
- Consumption in Standby mode with the indicator off: 0.016 mA.

Sample rate, kHz	Compression	Antialiasing	
		On	Off
16	no	3.6 mA	2.8 mA
8	no	3.4 mA	1.8 mA
4	no	3.3 mA	1.6 mA
16	log1-16	3.4 mA	3.4 mA
8	log1-16	3.3 mA	1.9 mA
4	log1-16	3.3 mA	1.5 mA
8	ADPCM2,4	3.2 mA	2.5 mA
4	ADPCM2,4	3.2 mA	1.6 mA

With the VAS on and the signal below equils the threshold, consumption does not exceed 0.2 ma. At playback the consumption is 5-7 m A in all modes.

## DVR overview

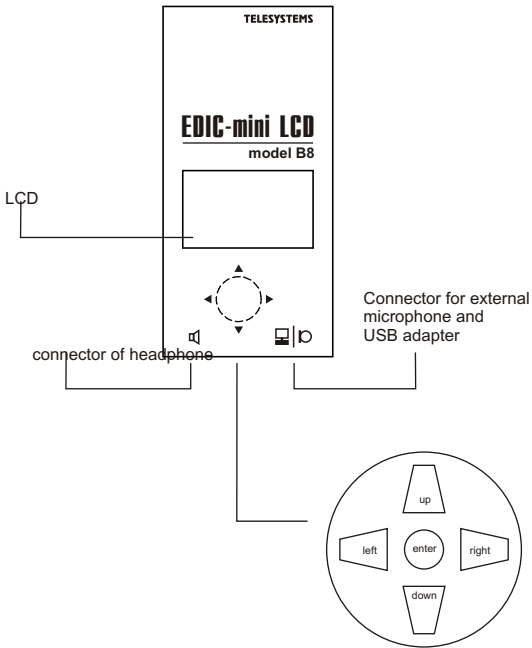

**EDIC-mini LCD B8 overview**



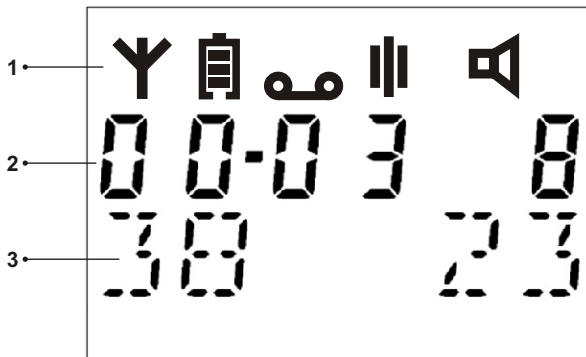

**Push-button joystick**

## Display Symbols



- 1 - Symbol line
- 2 - Numeric line
- 3 - Alphabetic line

- Indication of the DVR connection to PC by means of the USB adapter.

-  - Battery charge indicator;
-  - Record mode indicator;
-  - Standby mode indicator;
-  - Playback mode indicator



# DVR Operating

## Prestarting procedures

### Battery installation

We do recommend that only the batteries, produced by well known manufacturers should be used in the DVR. In this case you may expect your DVR to work continuously. Other battery types of the same dimension-type may provide less DVR operation time in Record and Playback modes, even if they are called compatible and announced to have better features.

When inserting the battery, make sure you have checked the polarity.

### Warning!

Special attention should be paid to polarity while inserting the battery: the positive battery contact is to be upward (the top side of the DVR is where the joystick and the display are).

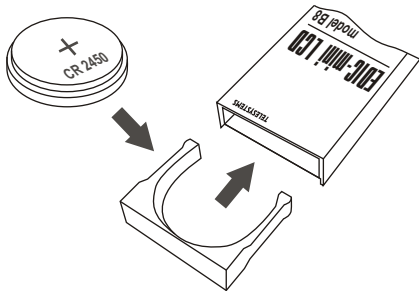

If the battery is inserted properly, the DVR will execute self-testing, and you will see the total memory capacity and firmware version on the display, then all the LCD elements will be indicated for a moment. After that you will see the following information on the display:

- In the symbol line battery charge indicator and mode symbol (Stop mode);
- In the numeric line the current time (hours and minutes), the separator blinks at a 2-second interval. (Fig. 1)

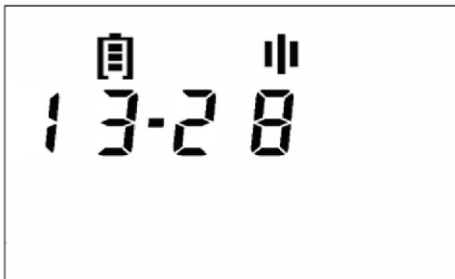

**Fig.1**

The DVR is in the Standby mode and ready to work. If left without a push-button activity for a minute, the DVR goes to Sleeping mode and the LCD display goes off. Push the joystick up to switch back it on.

## Battery replacement

Battery charge indicator shows how much battery life is left. If the battery is fully charged, the battery indicator border and three lines inside will be shown on the display



**Battery is fully charged**



**Battery is discharging**



**Battery is discharged**

If there is only the battery border on the display, it means that the battery is discharged and should be replaced. When the battery is discharged, the DVR does not react to the pressing or pushing of buttons, and the display remains off.

You can replace the battery without switching off the DVR. At that it can work for some seconds without the battery. Thus, if the battery is replaced fast enough, the built-in real time clock does not reset.

## Earphone and remote control connection

The headphone and remote control can be connected through the headphone connector on the side part of the case. You should fully insert the headphone plug into the connector.

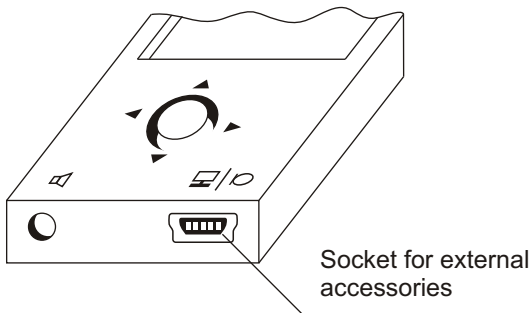

## Operating Modes

You can select a mode with the push-button manipulator (joystick) in accordance with the diagram. (See the control chart at the end of the manual).

If it is left without a push-button activity for a minute, the DVR switches to the Energy-saving mode and the LCD display goes off. Push the button up to switch it back on.

### Record mode (REC)

To start the Record mode, press the button once or twice, depending on settings made when connecting to the PC.

On the display you will see:

In the symbol line battery charge indicator and mode symbol;

In the numeric line on the left: net recording time (hours and minutes), the separator blinks at a 2-second interval; on the right: the current profile number;

In the alphabetic line on the left: the percentage of available memory, on the right: the number of the recording being made. (Fig. 2)

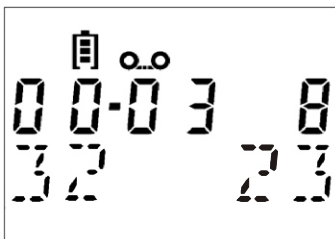

Fig.2

Push the joystick up to pause recording, PAUSE will appear on the display.



To continue recording, press the button once again.

If you push the joystick down, recording will stop, the DVR will go to Standby mode.

If there is no more free memory, the DVR will automatically go to Sleeping mode.

Recording may be saved either in the cycle buffer mode or in the line messages mode. The DVR can provide some memory size to the cycle buffer. (See Profile setting)

**Warning!** *When recording into the cycle buffer (cycle record), the DVR will start recording into the record beginning (i.e. deleting the previously recorded data), as soon as the provided memory space comes to the end. The time of the current record will go on, but the remaining memory size will stay constant on the display.*

Each recording made is marked with the time and date by means of the built-in real time clock.

You may adjust your DVR (see Setup mode) to record in the VAS mode. This will allow you to compress the pauses in messages efficiently therefore the available recording time increases. Using this system saves memory in pauses, but stores information about time intervals. The pause length can be restored at further file processing with the



supplied software.

In the VAS mode, while recording into flash memory, the Record symbol will be lit on the display. If the signal does not exceed the fixed level, and it is not recorded into flash-memory, there will be Record and Stop symbols on the display

You can adjust the VAS mode settings with the supplied software.

The VAS working algorithm is as follows: the DVR controller sleeps for T1 time, then it switches on for T2 time and analyzes the signal. If it discovers the X1 threshold exceeding by the signal during this time, the controller attempts to discover the X2 threshold exceeding by T4 time during T3 time. If the controller succeeds, the recording starts, otherwise the recorder continues sleeping. The recording stops, if the signal does not exceed the X3 threshold during T5 time and so on in cycle. The user can set T and X values, corresponding to software settings, to confirm to specific requirements.

### **Playback mode (PLAY)**

When you push the joystick down, PLAY will appear on the display. If you want to playback any recording, press the button to confirm choosing the Playback mode. Push the button right or left to select the recording number to be played. Then press the button, and the playback of the chosen record will start. The display will show the following information (Fig. 3):

- In the symbol line battery charge indicator and mode symbol;
- In the numeric line on the left: playback time (hours and minutes), the separator blinks at a 2-second interval, on the right: volume level;
- In the alphabetic line on the left: the size of the record segment played, as the percentage of the total record size, on the right: the number of the recording being played.

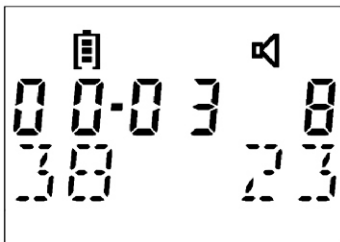

Fig. 3

You can change the volume by pushing the button up. The volume varies from 0 (off) to 8 (max).

If there are no recordings to be played, EMPTY will appear on the display. To exit this mode, push the button down.

### Erasing mode (CLEAR)

To erase a record, push the joystick down twice. You will see CLEAR on the display.





Press the button to confirm choosing this mode. Push the joystick right or left to select the number of the recording (NUM) to be erased and press the button. The available memory size will be indicated on the display, in percent according to the total size. If you press the button again, the next recording will be offered to be erased. If you have erased all the recordings or there are no recordings, EMPTY will appear on the display. It means that 100% memory is free. Press the button up to exit this mode.

### Tuning mode (REC PR)

The DVR provides eight settings of recording parameters (profiles). The DVR has the following preset profiles in the factory configurations. (Each profile contains its own set of recording parameters, including quality and voice compression at recording, VAS parameters, recording in linear/circular buffer). You can set profiles as you wish.

0	<b>Extra high</b>	Sampling rate 16 kHz, linear (without compression), 256 Kbit/s
1	<b>Super high</b>	Sampling rate 16 kHz, logarithmic compression (16 LOG), 128 Kbit/s
2	<b>Normal</b>	Sampling rate 8 kHz, logarithmic compression (16 LOG), 64 Kbit/s
3	<b>Medium</b>	Sampling rate 8 kHz, modified 4-bit ADPCM, 32 Kbit/s
4	<b>Extra high VAS</b>	Sampling rate 16 kHz, linear (without compression), VAS, 256 Kbit/s
5	<b>Super high VAS</b>	Sampling rate 16 kHz, logarithmic compression (16 LOG), VAS, 128 Kbit/s
6	<b>Normal VAS</b>	Sampling rate 8 kHz, logarithmic compression (16 LOG), VAS, 64 Kbit/s
7	<b>Medium VAS</b>	Sampling rate 8 kHz, modified 4-bit ADPCM, VAS, 32 Kbit/s

You can change the profile parameters using the Setup mode. (See Setup mode) We recommend you to select the profile before recording. For that, push the button down three times, you will go to the Tuning mode. Then press the button, and by pushing it right or left, select a profile (from 0 to 7). Press the button and PR SET will appear on the display. It means that the selected parameters are set. Then push the button up to go to the Standby mode.

Remember, that **the record time depends on the record quality: the higher is the quality, the shorter is the time.** You may approximately calculate the record time using the coefficient stated in the technical characteristics. To do this, divide the maximum record time of your DVR by the coefficient corresponding to the chosen parameters. In the Tuning mode, if without a push-button activity for 14 seconds, the DVR will switch to the Energy-saving mode. The chosen profile will be saved. These settings are also saved when replacing the battery.

### **Setup mode (SETUP)**

Push the button down four times to switch to the profile Setup mode. Here you can set the real time, check the available memory size and format it completely as well. Then press the button to enter the Setup mode. Then, pushing the button down, you can select from the following items (in circle):

1. Viewing the available memory size (MEM).

Press the button to view free memory in percent of the total memory size.

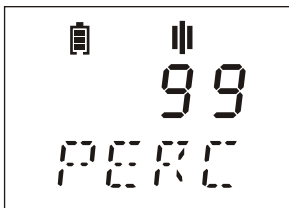

Push the button up to return to the Setup mode.

2. Profile setting (PROF). (See Profile setting mode)

3. Real time setting (TIME). Press the button to enter this mode. Push the joystick left to set hours, and right to set minutes. Then push it down and left/right to set the day, month and year.

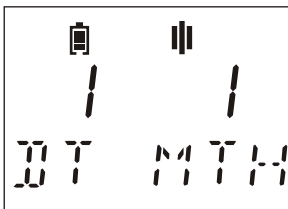
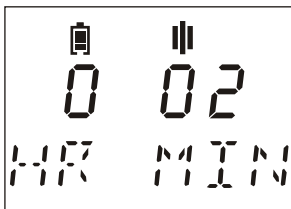

Then press the button, SET will appear on the display.

Push the button up to return to the Setup mode.

4. Memory formatting (FORMAT).

**Warning!** *At memory formatting, all the recorded messages will be lost.*

To format the memory, press the button. By pushing the button left or right, select YES and press the button again. DONE will appear on the display. Push the button up to return to the Setup mode.

If you do not want to format the memory, select NO, press the button or push it up. The DVR will return to the Setup mode.

5. Switching the record on/ off by single and everyday timer.  
(See Record startup on timer mode).

### **Profile setting mode**

Select the Setup mode (push the button down four times, then press it), then push the button down once and press it. The DVR is in the Profile setting mode now.

You can select parameter values by pushing the joystick left or right, and switch to the next parameter by pressing the button. Push the joystick up to return to the Setup mode.

First of all, select the profile number (NUM) by pushing the button left or right, and press the button. The DVR will offer to set (in cycle):

1. Audio sample rate (FREQ) of 4, 8 or 16 kHz.

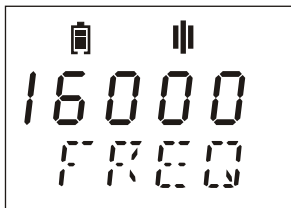

Set it by pushing the button left or right. Push the button down to go to the next parameter setting. Push the button up to return to the Setup mode (without saving the selected parameters).

If you press the button, the setting will be completed, and PR SET and the profile number will appear on the display.

2. Audio compression format. Push the button right to select the format, and left to select the parameter value.

- NO recording without compression;

- LOG logarithmic compression. You can set the sensitivity parameter (1, 2, 4, 8 or 16) by pushing the joystick to the left. The parameter depends on recording conditions. You should set a low parameter value to make a high quality record of a weak signal; the strong signal will be recorded with distortion. If the parameter value is big, loud signals will be recorded at high quality, but low signals can be fuzzy.

- ADPCM Adaptive Differential Pulse Code Modulation. You can set the parameters (2 or 4) by pushing the joystick to the left.

You may set the following quality, formats and density of the data recording:

- Without compression (linear), sample rate is 16 kHz, 256 Kbit/s, k=16
- Without compression (linear), sample rate is 8 kHz, 128 Kbit/s, k=8
- Without compression (linear), sample rate is 4 kHz, 64 Kbit/s, k=4
- Logarithmic compression, sample rate is 16 kHz, 128 Kbit/s, k=8
- Logarithmic compression, sample rate is 8 kHz, 64 Kbit/s, k=4
- Logarithmic compression, sample rate is 4 kHz, 32 Kbit/s, k=2
- Modified 4-bit ADPCM, sample rate is 8 kHz, 32 Kbit/s, k=2
- Modified 2-bit ADPCM, sample rate is 8 kHz, 16 Kbit/s, k=1
- Modified 4-bit ADPCM, sample rate is 4 kHz, 16 Kbit/s, k=1
- Modified 2-bit ADPCM, sample rate is 4 kHz, 8 Kbit/s, k=0.5

where k is the coefficient, showing how many times the maximum recording time decreases at record quality increase. You should

remember: the higher is the quality, the less is the time. You may approximately calculate the record time with the parameters set, dividing the maximum record time of your DVR by the coefficient appropriate to the selected parameters.

Push the button down to go to the next parameter.

Push the button left or right to select VAS or to stay in the normal mode (NORM). Then push the button down.

You will see LINE on the display which means the line record mode is on. Push the button left or right (one time) to select cycle record mode. The figure in the Cycle mode means the buffer size in percent of total memory size.

Press the button, when you have finished setting the parameters. PR SET and the profile number will appear on the display.

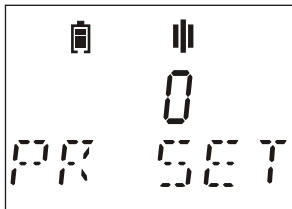

### **Recording startup by timer**

The DVR can start and finish recording by the timer. There are two different timers: a single and everyday timer.

*Single timer* starts and stops recording at preset time (minutes, hours, day, month and year).

*Everyday timer* starts and stops recording at preset time of the day (minutes and hours). It will work day after day until the timer is switched off.

You can set the time accurately within seconds, using a PC. It is possible to view the starting and finishing time (within minutes) and switch on/off timers from the DVR menu.

The timer starts/stops recording only if the USB is not connected, and the DVR is not in Standby mode due to a battery discharge. If the recording was on when the timer started, it will continue. If the user interrupts recording (which was started by the timer), he/she has to restart recording manually, otherwise the record will stop.

### **Standby mode (STOP mode)**

When switched on, the DVR is in the Standby mode for some time. You can see the real time and battery charge level on the display. Press the button (once or twice, depending on the DVR settings), to start recording. Pushing the button down, you may select modes (Playback, Erasing, Tuning and Setup modes). If without a push-button activity for minute, the DVR switches to the Energy-saving mode, the LCD display goes off. Push the button up to switch it back on.

### **Energy-saving mode**

If without a push-button activity for minute, the DVR switches to the Energy-saving mode. The DVR goes to this mode from most other modes if there is no push-button activity for a minute. The LCD goes off then. If the device is in the Setup mode, the DVR will switch to the Energy-saving mode having saved the parameters chosen by you. Push the button up to switch the display on. Press the button if you want to go to the Record mode.

### **Admission levels**

To make the DVR convenient to use (data failure protection, protection against accidental actions or unauthorized operation), there are three levels of admission to DVR functions available from joystick, using the

supplied software. (See the diagram in the enclosed paper)

**First admission level (USER):** only recording is possible in the DVR.

**Second admission level (OPERATOR):** Record, Playback, Erasing and Tuning modes are available.

**Third admission level (ADMIN):** complete admission to all modes and parameter setting.

### **Antialiasing median program filter**

There is an opportunity of applying an antialiasing median program filter to improve recording (especially with the sample rate of 4 and 8 kHz) and playback quality. You may activate this function with the software. It should be borne in mind that applying the filter will result in DVR current drain increase and battery resources decline. (See the current drain table)

## **Connection to Computer**

### **System requirements**

To be able to operate with the DVR and set parameters setting your PC should have:

1. Operating system Windows 9x/Me/NT/2000/XP.
2. Sound card available.
3. USB plug available.

### **Connection**

The DVR is to be connected into the USB socket of the PC through the supplied USB adapter.

The DVR should be connected to the adapter through the connector on the right side, with a display picture.



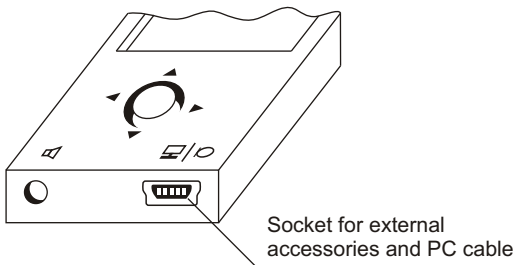

You will see the Y at the beginning of the symbol line.

Warning! The DVR does not react to joystick movements, with the adapter connected.

To operate the DVR, you should install the software from the supplied CD.

The software has a user-friendly interface, and no special skills are required to connect the DVR.

### **Firmware updating**

To update the firmware you should:

1. Download the updated firmware from the manufacturer's web site;
2. Unpack the archive with two files in one folder;
3. Remove the battery from the DVR;
4. Connect the adapter;
5. Push the joystick in any direction;
6. Keeping the button pressed and the adapter connected to the DVR, insert NEW or NOT DISCHARGED battery into the DVR;

7. Start the exe-file;
8. Then follow the instructions in the console application window and wait until the updating is completed (1-3 minutes);
9. Remove the battery and insert it again in 10 seconds. At switching on, the DVR will indicate the new firmware version.

Warning! Be sure that the battery is not discharged (no empty “lines” must be indicated on the display) to succeed in updating.

If the firmware updating failed for some reason (battery discharged, computer switched off or adapter disconnected during the updating process) and the DVR did not switch on with the power supplied just repeat the procedure again. All the audio files recorded and DVR settings will be saved with the firmware updating.

## **DVR Accessories**

**Warning!** *When purchasing, please, do mention the DVR type you buy accessories for.*

You may use accessories of type 3 with this DVR model.

### **1. External microphone with a compressor, combined with the remote control**

The external microphone has relative sensitivity of +6 dB in the far zone (far than 1 meter) and -6 dB in the near zone (nearer than 1 meter) against the built-in microphone. For connection, you should use the special connector for the external microphone, which is on the right side of the case.

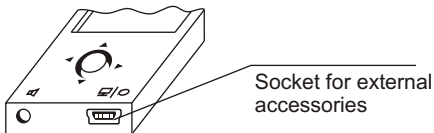

Connecting the external microphone will disable the built-in microphone; only the external microphone will be used at recording. The remote control is a push-to-lock button. It allows the user to start and stop recording remotely. Press the button and keep it pressed for more than 0.5 second to enter the Record mode. Release the button for more than 0.5 second to go to the Stop mode.

The DVR will go to the Record mode from other modes if you press the button on the remote control and keep it pressed for more than 0.5 second. Release the button for more than 0.5 second to go to the Standby mode.

## **2. Phone talk record adapter**

This adapter makes it possible to record phone talks. It is connected to the optional DVR unit connector. With the supplied software you should adjust the configuration to automated recording of phone talks. Then the DVR will automatically start recording at raising the telephone receiver and stop at putting it back.

## **3. Record adapter for cellular phone with a stereo connector**

This adapter makes it possible to record cellular phone talks. A stereo connector should be provided for in the cellular phone to use this application. The adapter is connected to the optional DVR unit connector. supplied software you should adjust the configuration to automated recording of cellular phone talks.

## Troubleshooting: possible causes and corrective measures

When using the DVR at low temperatures, slowing down and decreased operation speed are possible picture in the LCD display dithers and/or changes slowly. This is not troubleshooting.

<b>Problem</b>	<b>Possible causes</b>	<b>Possible corrective measures</b>
After inserting the battery, there are no symbols indicated on the display. The DVR does not react to joystick pushing.	The battery is discharged; the battery polarity is not observed.	Replace the battery. Insert the battery according to the indicated polarity.
There is a message ERR_XX on the display. It goes off only at power disconnecting.	DVR failure.	The DVR needs repairing in the service center.
The DVR does not start recording.	There is no free memory.	Clear the memory. Delete some messages.

<b>Problem</b>	<b>Possible causes</b>	<b>Possible corrective measures</b>
The DVR does not switch to the record mode and does not react to joystick pushing.	The battery is completely discharged.	Replace the battery.
There is no sound heard in the earphone in the Playback mode.	<ol style="list-style-type: none"> <li>1. The volume is not adjusted.</li> <li>2. The headphone is not completely inserted.</li> <li>3. The headphone is broken.</li> </ol>	<ol style="list-style-type: none"> <li>1. Set a higher volume.</li> <li>2. Insert the head phone completely.</li> <li>3. Try another head phone.</li> </ol>
The DVR does not connect to the computer.	The USB adapter drivers are not installed.	Install/reinstall drivers for the USB adapter.

## Technical Support

You can get technical support comes through e-mail:  
**support@ts-market.com**,  
free of charge.

New software versions are free for downloading on the company web site:  
**<http://www.ts-market.com>**.

Should anything in the operation manual be unclear, be sure to contact the manufacturer for clarification.



## EDIC-mini LCD B8 menu control chart

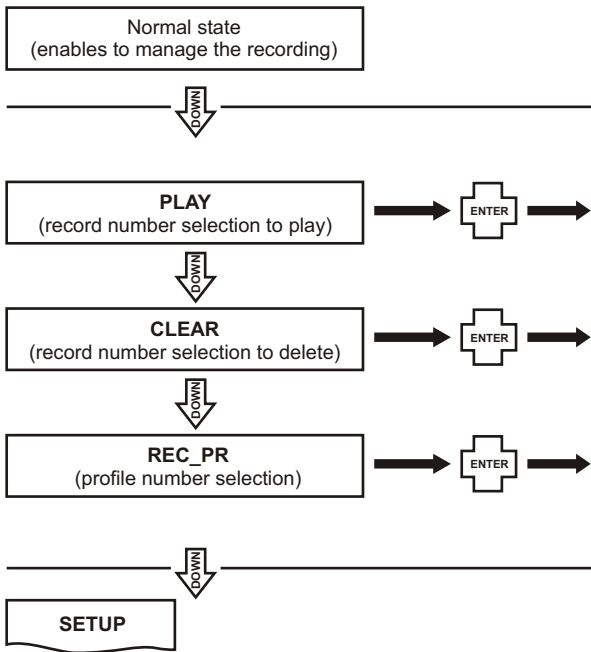



## The first (the lower) access level

---

### The second (mean) access level

Record number selection



Record number selection



Profile number selection



---

### The third (top) access level (see the next double page)

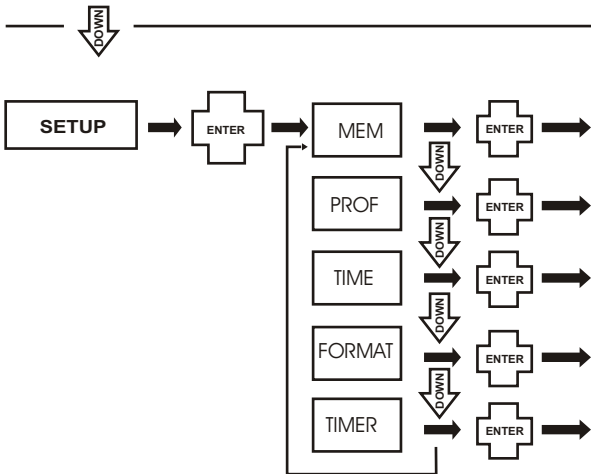

## The second (mean) access level (see the previous double page)

---

### The third (top) access level

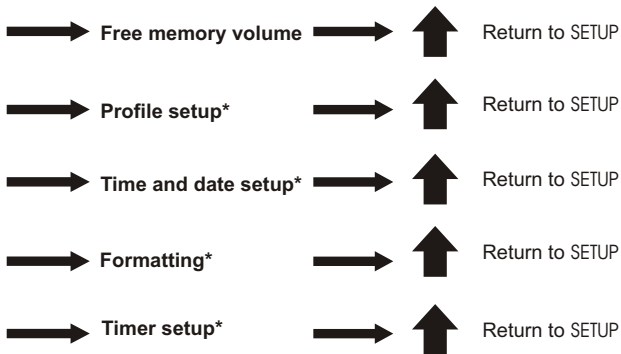

\* the detailed chart of this option can be found on the next double pages



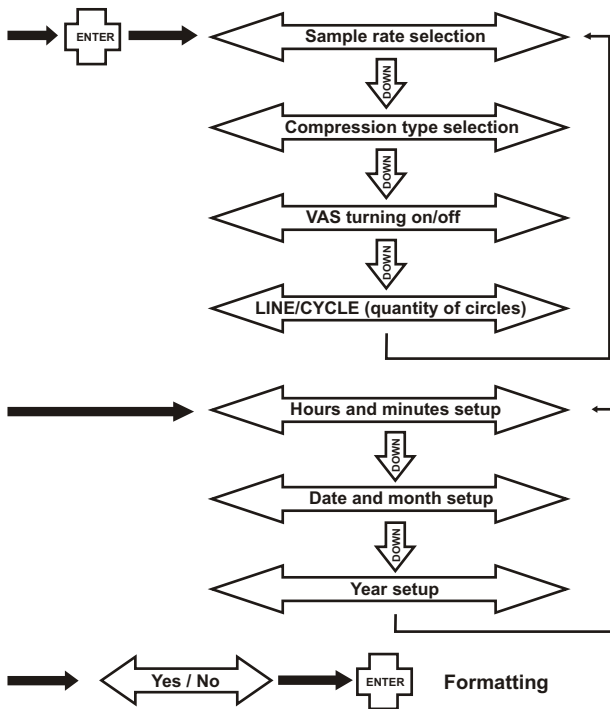

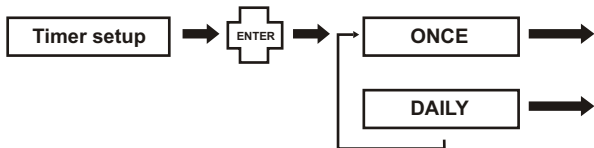

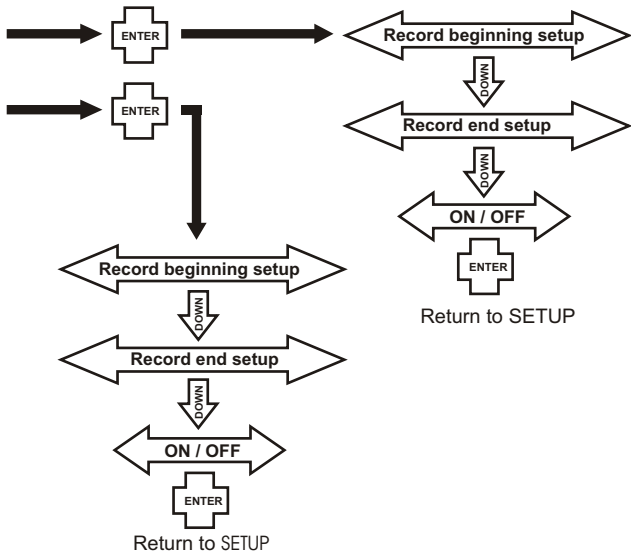

**Developed and produced by Telesystems Ltd.**

## **Guarantee card**

Telesystems company undertakes obligations of guarantee repairs of the product within 1 year from the date of sale. Claims for guarantee repairs are not accepted at:

- operation rules violating;
- mechanical damages;
- absence of Telesystems' stamp on the present document.

All the questions concerned returning and exchanging the product, are solved in accordance with the Consumer protection laws.

Warning! The guarantee does not cover batteries.

Number \_\_\_\_\_

Model:

**B8-560**

**B8-1120**

**B8-2240**

**B8-4480**

**B8-8960**

Quality control department \_\_\_\_\_

Date of sale \_\_\_\_\_

Seller \_\_\_\_\_

### **Address:**

B.10-1, Sosnovaya alleya, Zelenograd, Moscow 124489,  
the Russian Federation

Phone: +7 (495) 530-10-01

Fax: +7 (495) 535-04-91

E-mail: [support@ts-market.com](mailto:support@ts-market.com)

<http://www.ts-market.com>